



English

Workbook

2



+ Підсумкові
семестрові
роботи

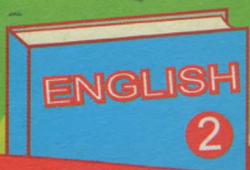



До підручника
Г. Пухти та ін.

1  Tick (✓) and say what is in your classroom.
Познач (✓) і скажи, що є у твоїй класній кімнаті.

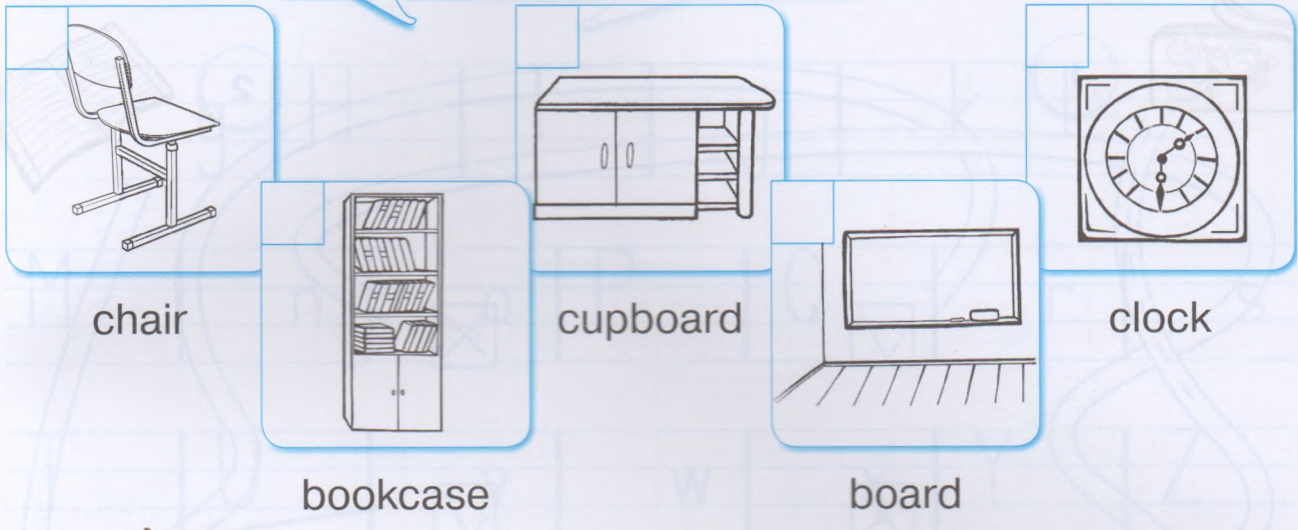
It's a



chair bookcase cupboard board clock

2   Find the words, circle and copy.
Знайди слова, обведи та перепиши.

rtydoorthchairgcfloordjhwindowdfwallh

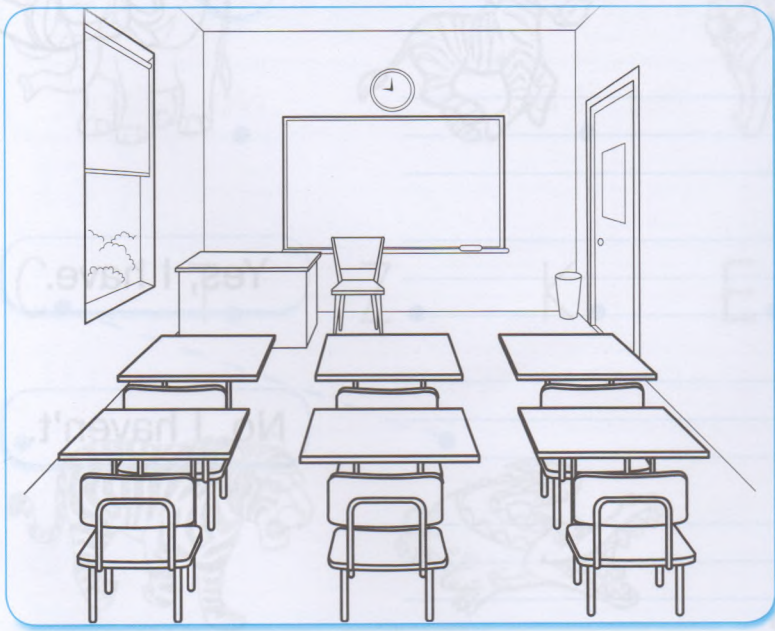

door

1



Join and write answers.

З'єднай і напиши відповіді.

Have you got a ... ?



1



2



3



4

1 _____

2 _____

3 _____

4 _____

Yes, I have.

No, I haven't.

1



Write the letters from A to Z. Дopiши лiтери вiд A до Z.

A	a	b	c	D	e	F
g	H	I	J	k	L	
M	n	o	P	Q	r	s
T	U	v	w	x	Y	Z

2



Name and match. Назви та з'єднай.

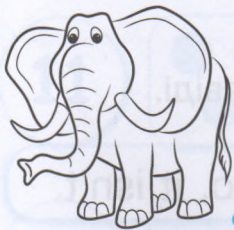

C

T

Z

K

E

Y

D

W



1



Read and match. Прочитай і з'єднай.

pencil

pen

book

bag

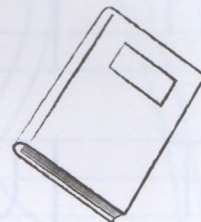
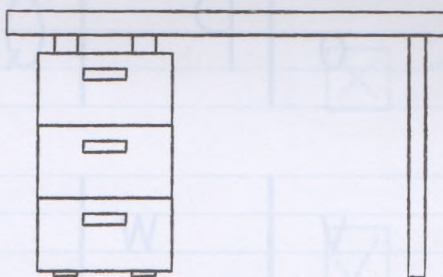
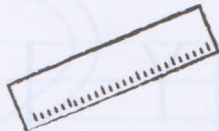

rubber

ruler

notebook

desk

2



Look and write answers. Поглянь і напиши відповіді.

Yes, it is.

No, it isn't.

1 Is it a bag?



2 Is it a chair?



3 Is it a clock?



1

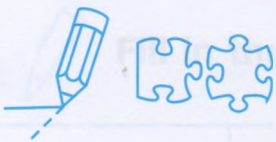

Trace and match.

Наведи та з'єднай.

twelve eighteen thirteen twenty

sixteen 11 12 13 14 15 eleven

16 17 18 19 20

nineteen seventeen fourteen fifteen

2



Colour and write. Зафарбуй і напиши.

11 ● ● ● ● ● ● ○ ○ ○ ○ ○ ○ eleven

13 ○ ○ ○ ○ ○ ○ ○ ○ ○ ○ ○ ○ _____

16 ○ ○ ○ ○ ○ ○ ○ ○ ○ ○ ○ ○ _____

20 ○ ○ ○ ○ ○ ○ ○ ○ ○ ○ ○ ○ _____

1



Fill in the blanks. Заповни пропуски.

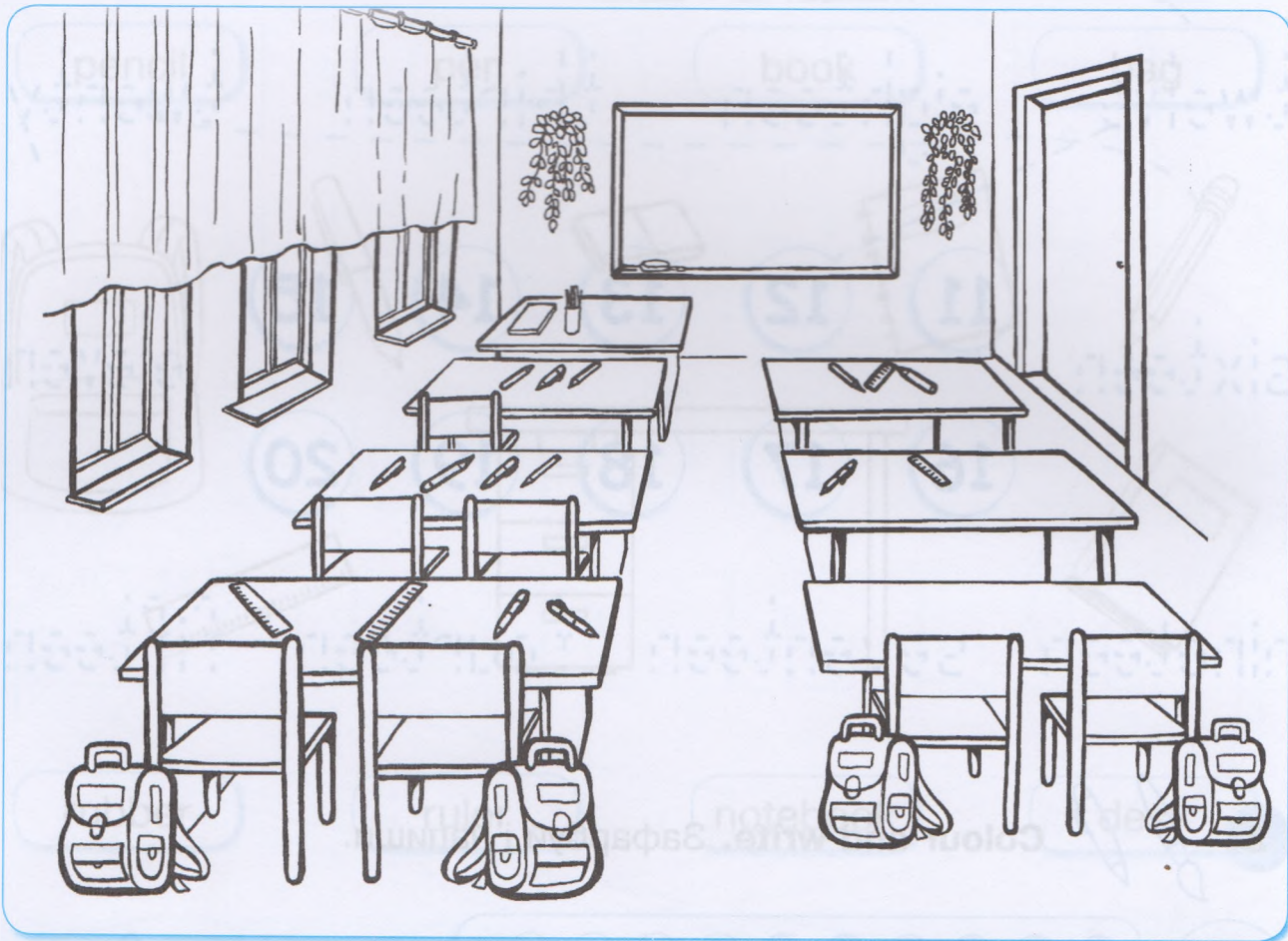

1 There are some pencils.

2 _____ a board.

There is...

3 _____ 4 bags.

4 _____ some desks.

There are...

5 _____ 1 book.

1



Fill in the blanks. Заповни пропуски.

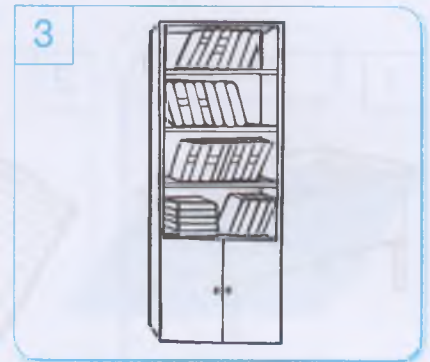
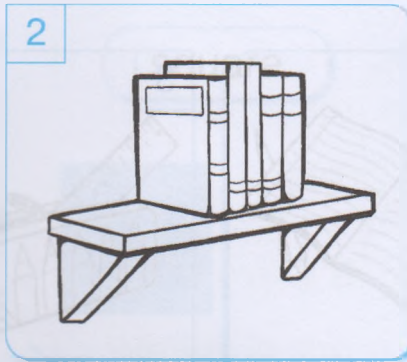
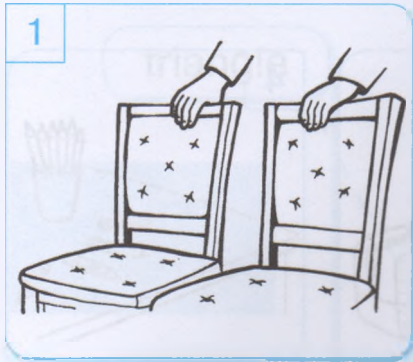

1 There are 2 chairs.

4 There _____ a notebook.

2 There _____ 5 books.

5 There _____ 18 pencils.

3 There _____ a bookcase.

6 There _____ a ruler.

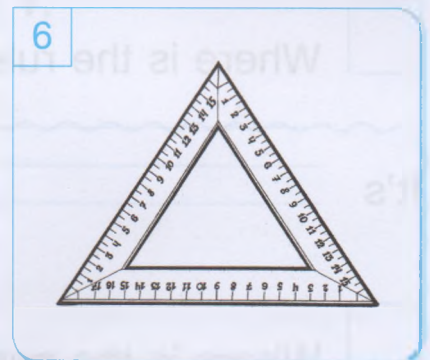
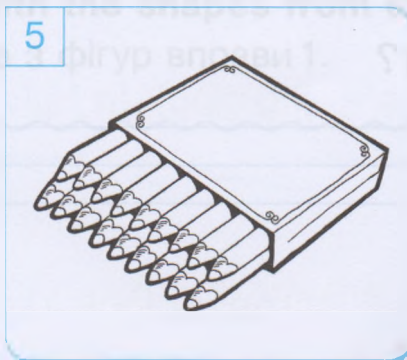

2



Сору. Перепиши.

There is a pencil case. There are some pencils.



1 Match and complete.
З'єднай і допиши.

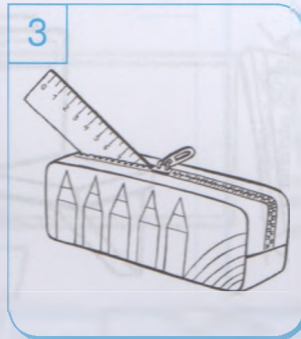
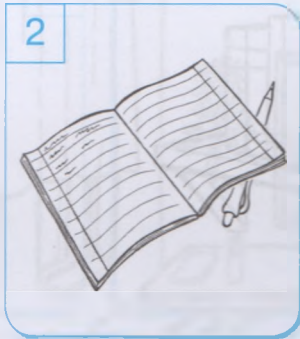
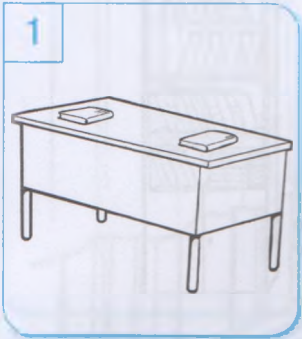

4 Where are the pencils?

They're on the desk.

Where is the ruler?

It's _____

Where is the pen?

It's _____

Where are the books?

They're _____

1  Read and match. Прочитай і з'єднай.

triangle square circle

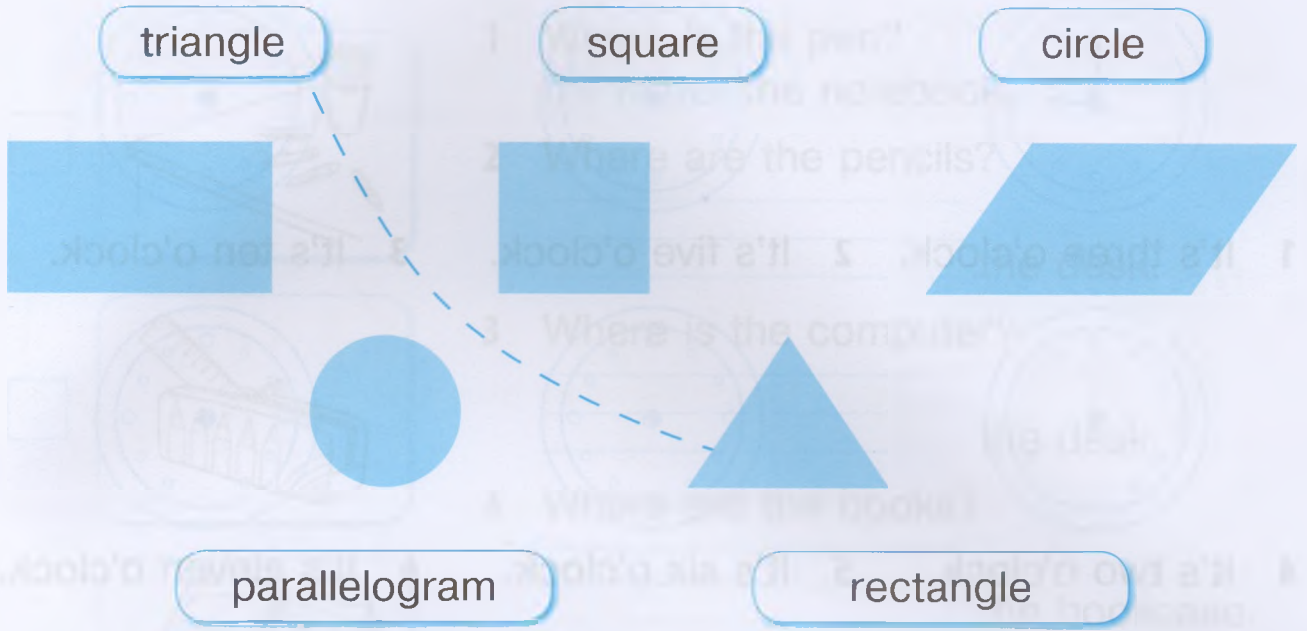

parallelogram rectangle

2  Draw a cat with the shapes from ex. 1.
Намалюй кота з фігур вправи 1.



1  Read and draw. Прочитай і намалюй стрілки годинника.

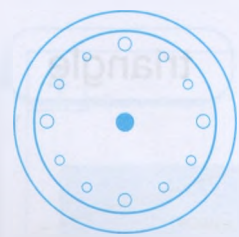
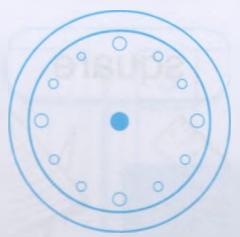
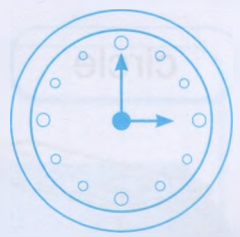

1 It's three o'clock. 2 It's five o'clock. 3 It's ten o'clock.

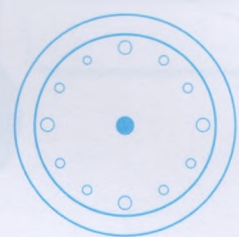
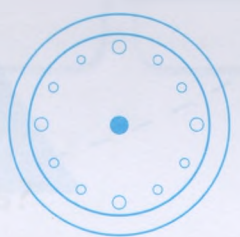
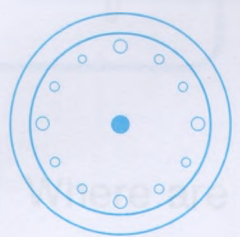

4 It's two o'clock. 5 It's six o'clock. 6 It's eleven o'clock.

2  Match and say. З'єднай і скажи.

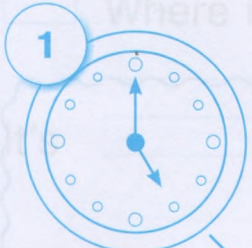

Kyiv

It's five o'clock in Kyiv.



Paris

three o'clock

ten o'clock

five o'clock

four o'clock

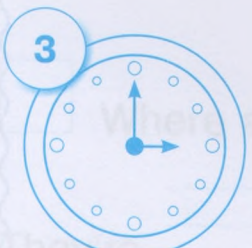

London

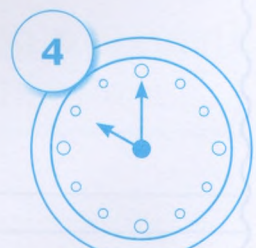

New York

1



Number and fill in the blanks.

Пронумеруй і заповни пропуски.

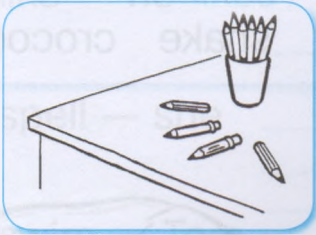

1 Where is the pen?
It's **under** the notebook.

2 Where are the pencils?
_____ the desk.

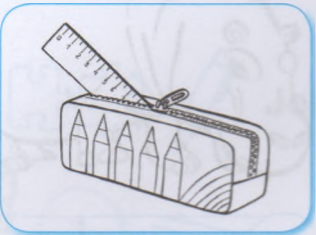

3 Where is the computer?
_____ the desk.

4 Where are the books?
_____ the bookcase.



5 Where is the pencil?
_____ the book.

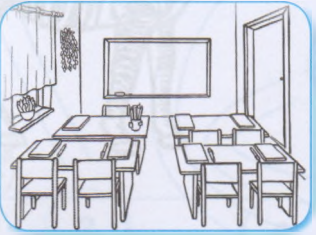

6 Where is the ruler?
_____ the pencil case.

7 Where are the desks?
_____ the classroom.

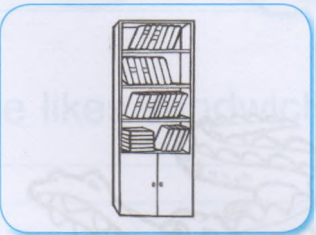

8 Where is the bag?
_____ the desk.

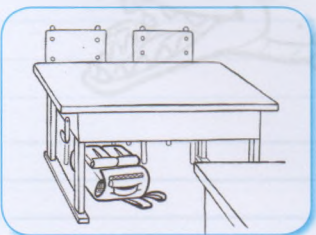

1



1  Look and write. Поглянь і напиши.

parrot hippo zebra monkey tiger bear snake crocodile



1

2

3

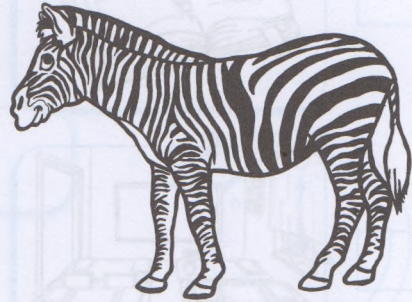
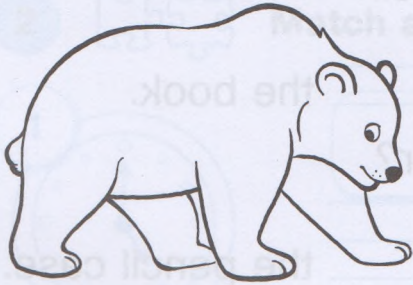

4

5

6

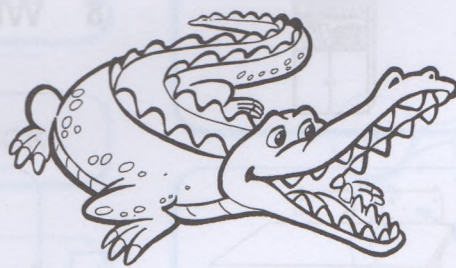



7

8

1  **Complete.** Допиши.

- | | |
|---------------------------|-----------------------|
| 1 I like — he likes _____ | 4 I jump — Ann _____ |
| 2 I spell — she _____ | 5 I write — mum _____ |
| 3 I swim — Tom _____ | 6 I read — dad _____ |

2   **Join and write.** З'єднай і напиши.

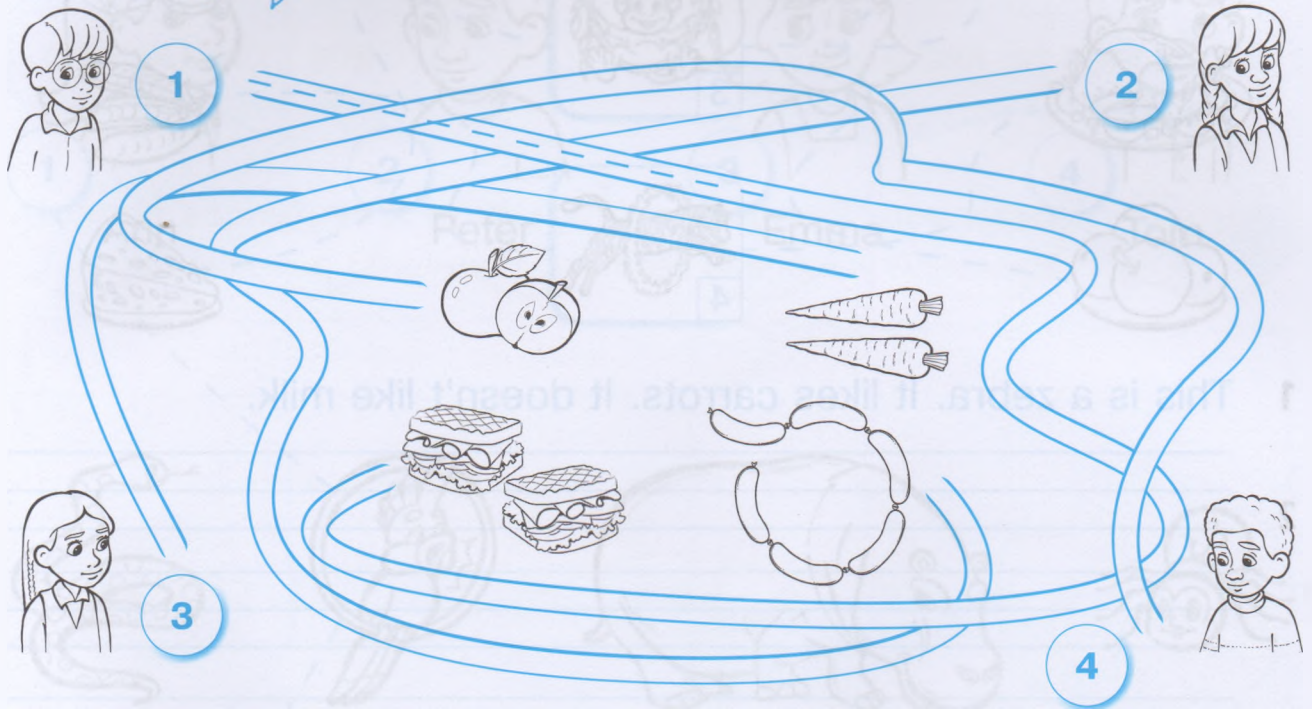

- 1 He likes sandwiches.
- 2 _____
- 3 _____
- 4 _____

1 

Join and write. З'єднай і напиши.

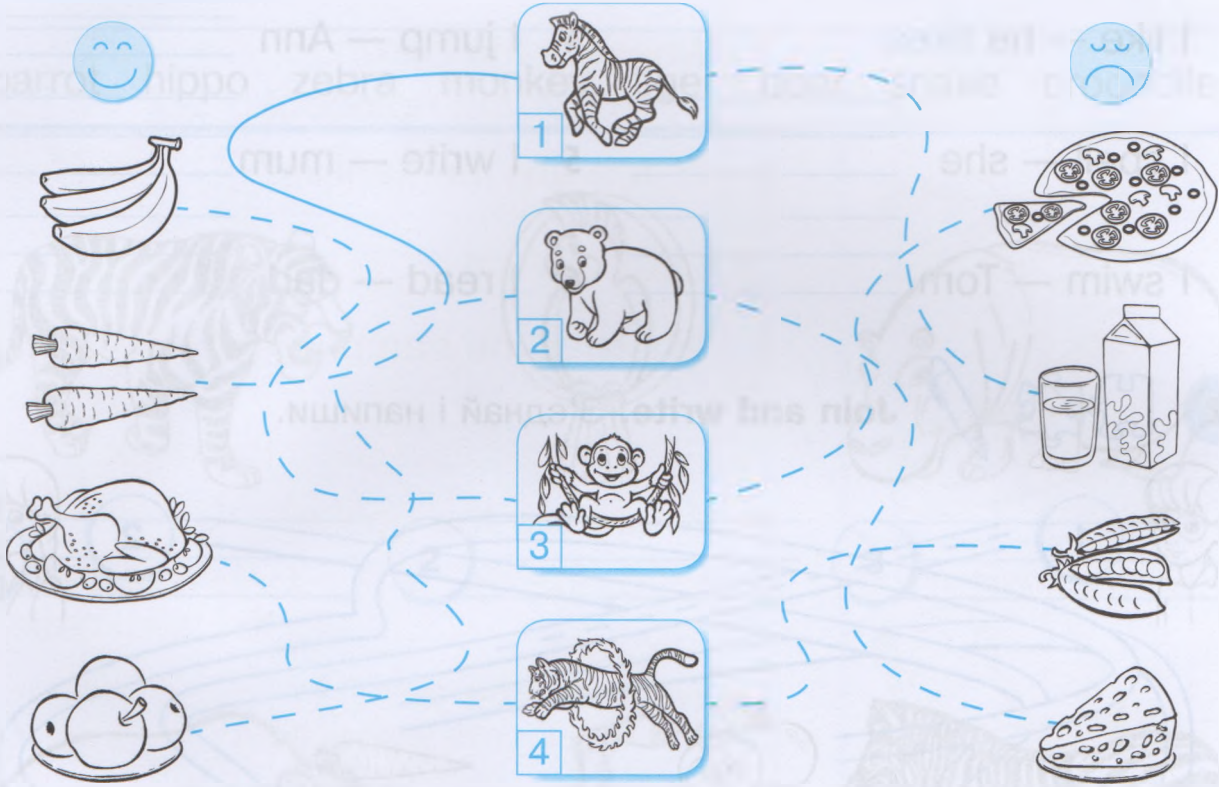

1 This is a zebra. It likes carrots. It doesn't like milk.

2 _____

3 _____

4 _____

1  Read and match. Прочитай і з'єднай.

1 — Does Ann like parrots?
— Yes, she does.

3 — Does Emma like spiders?
— No, she doesn't.

2 — Does Peter like snakes?
— No, he doesn't.

4 — Does Tom like hippos?
— Yes, he does.

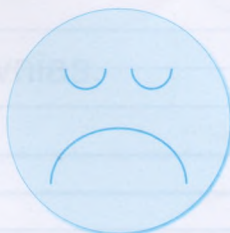
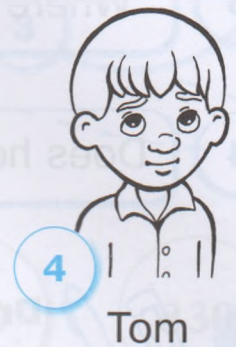
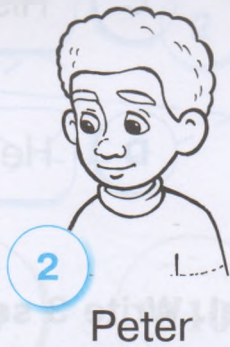

1  **Read and match.** Прочитай і з'єднай.

- | | |
|-------------------------------------|------------------------------------|
| <p>1 What's his name?</p> | <p>A He is eight.</p> |
| <p>2 How old is he?</p> | <p>B No, he doesn't.</p> |
| <p>3 Where's he from?</p> | <p>C His name is Mark.</p> |
| <p>4 Does he like pizza?</p> | <p>D He's from Ukraine.</p> |

2  **Draw your favourite animal. Write 3 sentences about it.**
 Намалюй улюблену тварину. Напиши 3 речення про неї.



1  Join and write answers. З'єднай і напиши відповіді.

How much?

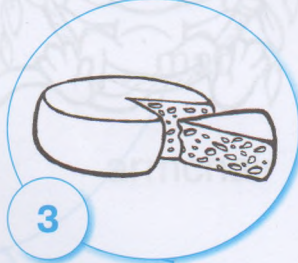
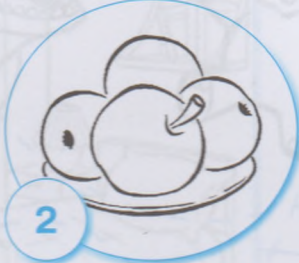

£12

£50

£10

£25

£20

£30

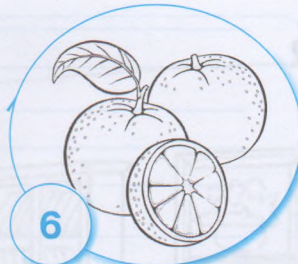
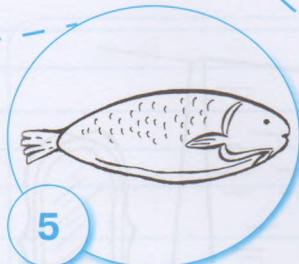

1 It's 25 hryvnias.

2 They're 12 hryvnias.

3 _____

4 _____

5 _____

6 _____

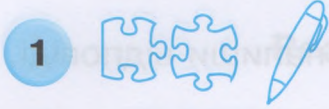

1 Join and write. З'єднай і напиши.

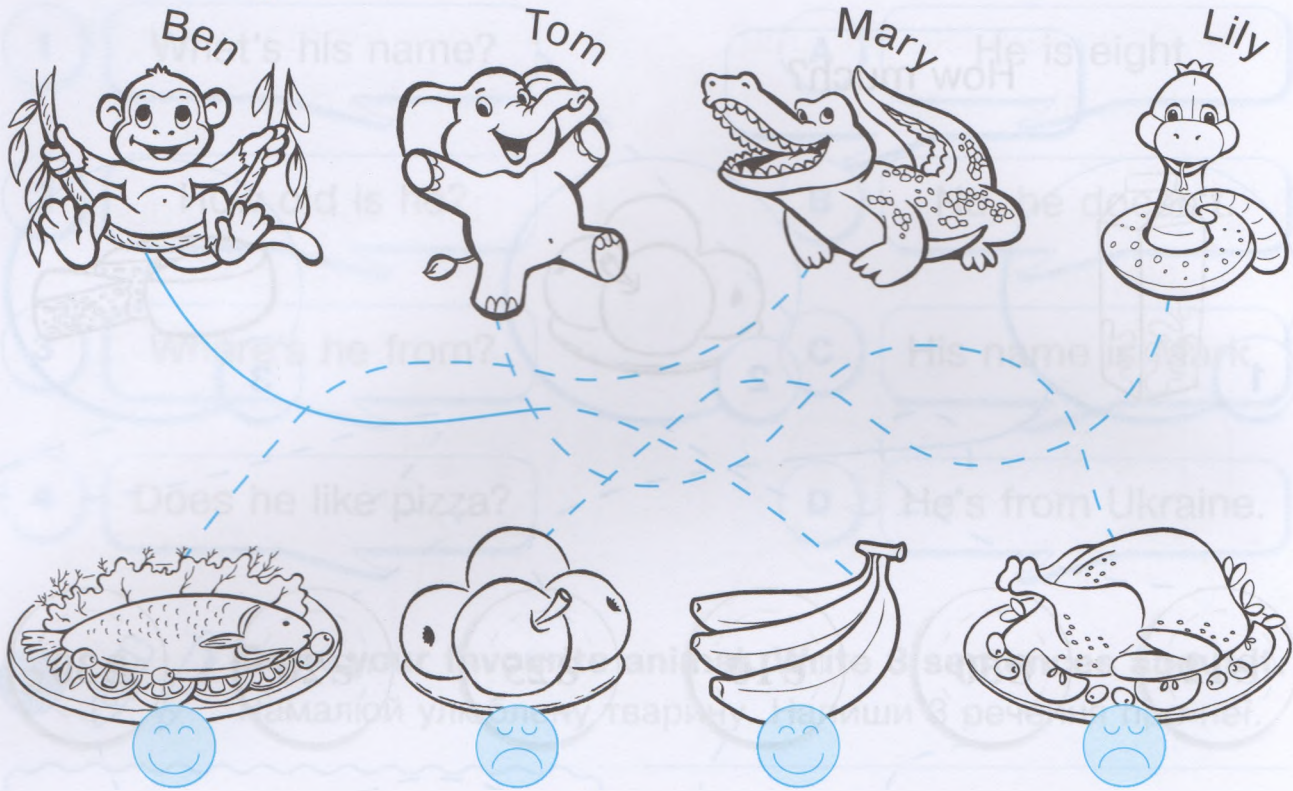

1 Does Ben the monkey like bananas? — Yes, he does.

2 _____

3 _____

4 _____

1



Find, circle and name. Знайди, обведи та назви.

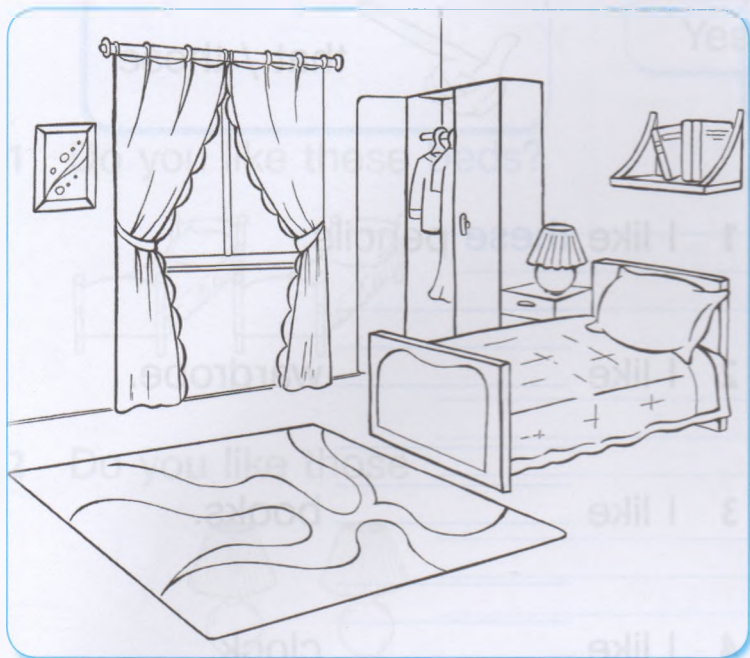

bed

table

chair

mat

sofa

armchair

lamp

mirror

cupboard

clock

bookcase

wardrobe

2



Read and draw. Прочитай і домалюй.

The red ball is on the sofa. The green ball is on the mat. The yellow ball is on the armchair. The blue ball is under the mirror.

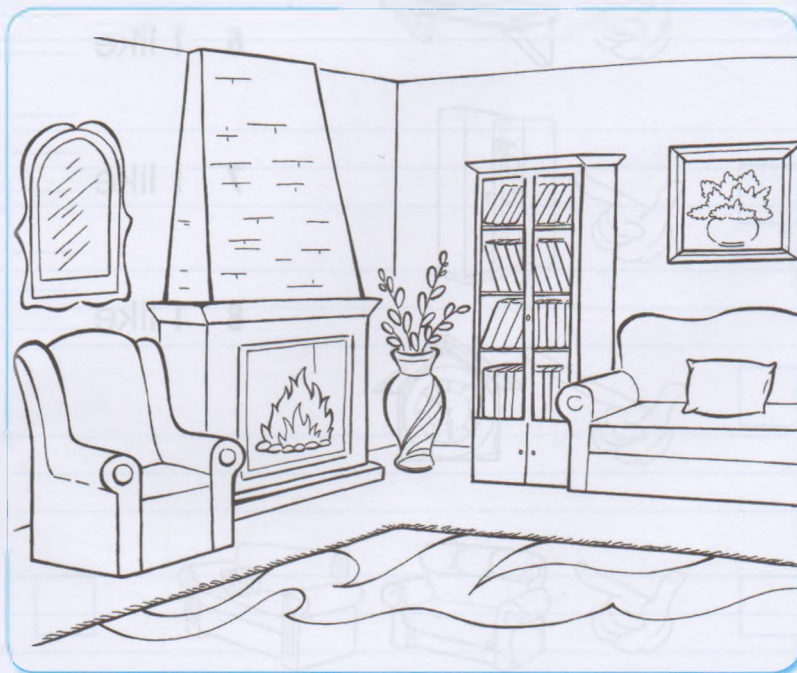

1



Number and fill in the blanks.

Пронумеруй і заповни пропуски.



this / these



that / those

1

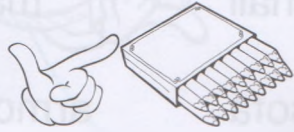

1 I like these pencils.



2 I like _____ wardrobe.

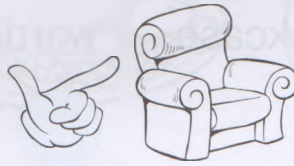

3 I like _____ books.

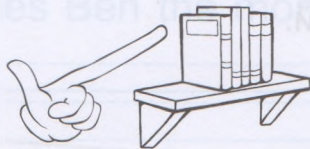

4 I like _____ clock.

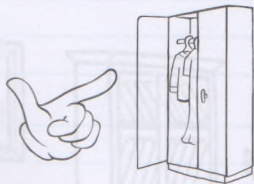

5 I like _____ chairs.

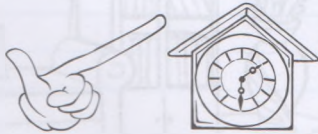

6 I like _____ armchair.



7 I like _____ lamp.





1

Complete the questions. Write your answers.

Допиши запитання. Напиши свої відповіді.

Yes, I do.

No, I don't.

1 Do you like these **beds**?



2 Do you like those



3 Do you like these

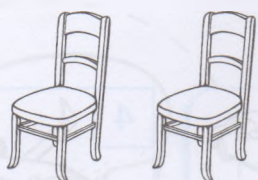

4 Do you like those



5 Do you like these



1  Fill in the blanks. Заповни пропуски.

my ball → mine

your ball → yours

1 This is your cap. — It's yours.



2 These are my socks. — They're _____



3 This is my skirt. — It's _____



4 This is your sweater. — It's _____





5 These are my jeans. — They're _____



6 These are your shorts. — They're _____



2  Look and write. Поглянь і напиши.

1 
my

2 
your

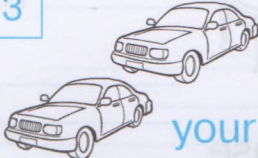
3 
your

4 
my

1 The book is mine.

2 _____

3 _____

4 _____

1



Read and circle what is in the bins.

Прочитай та обведи те, що є в кошиках для сміття.

Glass — blue

Paper — yellow

Fruit & vegetables — green

Plastic — red

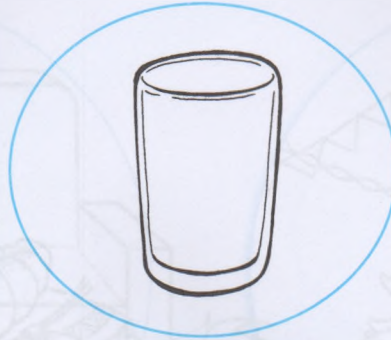



1

Match and complete. З'єднай і допиши.



C

N



1
2
3
4
5

1



Write what the boy says. Напиши, що каже хлопчик.

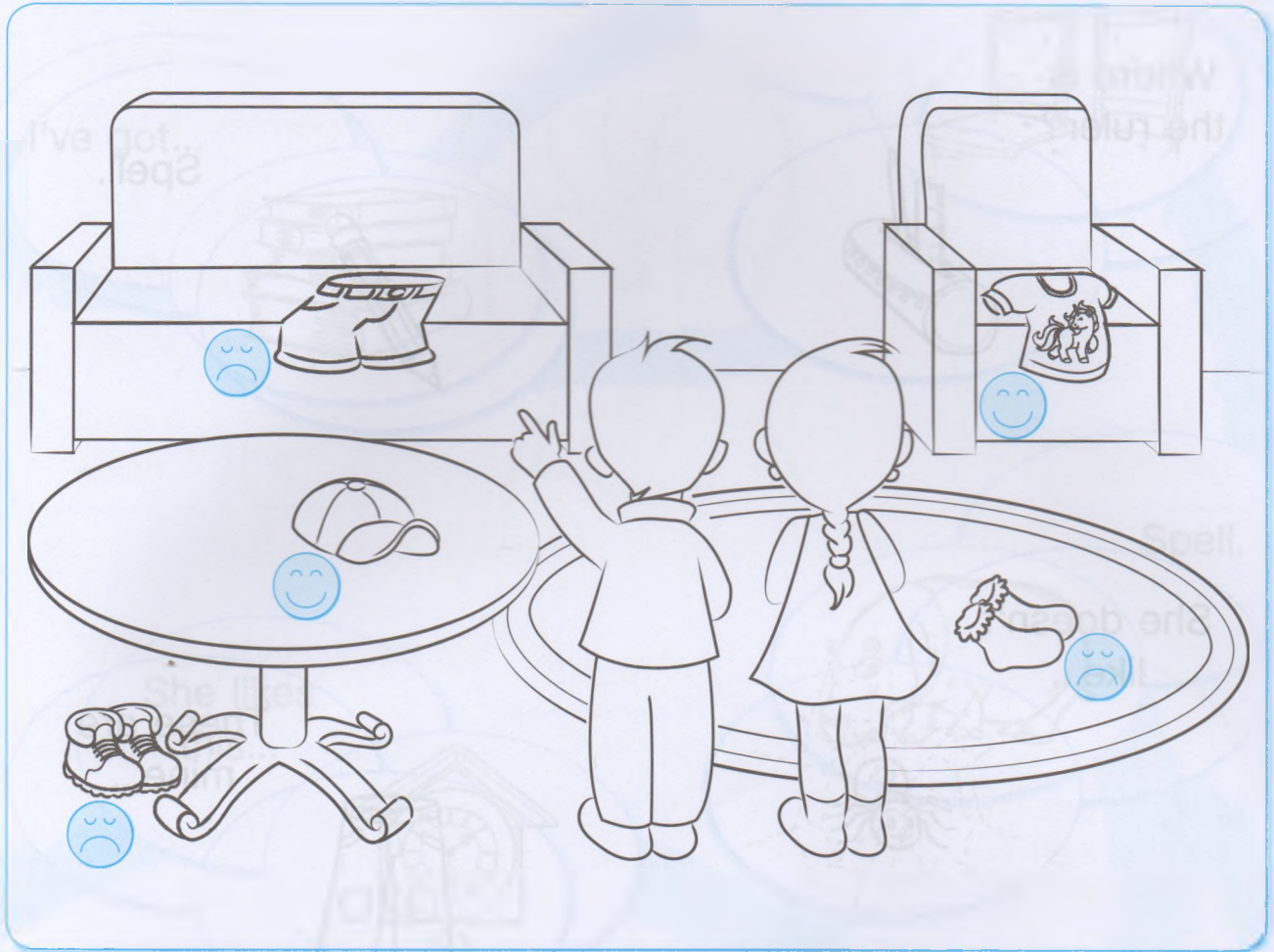

1 I don't like these shorts. They're mine.

2

3

4

5

1  Play and say. Пограйся і скажи.

Where is the ruler?

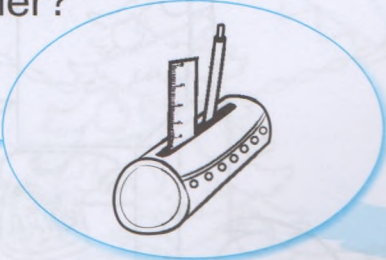

Spell.



She doesn't like...

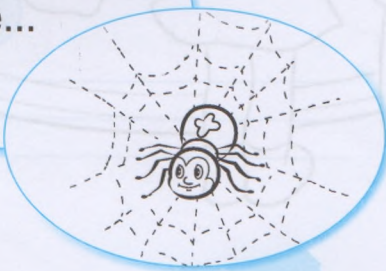

These are mine...

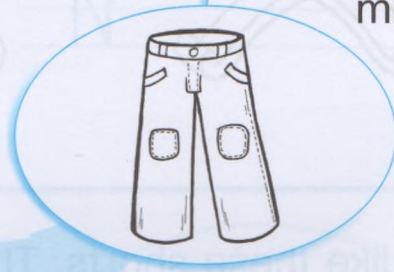

Spell.



I like that...



I've got...



There are some...



She likes this...



Spell.



Spell.

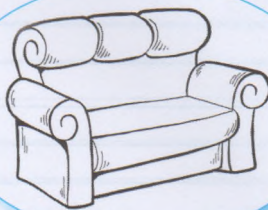

Where's the dress?



1  **Match and write answers.** З'єднай і напиши відповіді.

ears

1

7

hair

face

2

6

eyes

glasses

3

5

nose



4

mouth

- 1 What are these? — They're your ears.
- 2 What's this? — It's your face.
- 3 What are these? — _____
- 4 What's this? — _____
- 5 What's this? — _____
- 6 What are these? — _____
- 7 What's this? — _____

1



Tick (✓) true (T) or false (F).

Познач (✓), які речення відповідають малюнку, а які — ні.

- 1 She's got long hair.
- 2 She's got two noses.
- 3 She's got a mouth.
- 4 She's got big eyes.
- 5 She's got glasses.
- 6 She's got small ears.

	T	F
1	<input checked="" type="checkbox"/>	<input type="checkbox"/>
2	<input type="checkbox"/>	<input type="checkbox"/>
3	<input type="checkbox"/>	<input type="checkbox"/>
4	<input type="checkbox"/>	<input type="checkbox"/>
5	<input type="checkbox"/>	<input type="checkbox"/>
6	<input type="checkbox"/>	<input type="checkbox"/>



2



Copy and colour. Перепиши та розфарбуй.

This is Mike. He's six. He's got brown hair and green eyes.



This is Ann. She's seven. She's got red hair and blue eyes.



1



Fill in the blanks. Заповни пропуски.

eyes

black

Sam

seven

nose

small

This is (1) Sam. He is (2) _____.

He's got (3) _____ hair, green

(4) _____, (5) _____

ears and a small (6) _____.



2



Read and draw a face.

Прочитай і намалюй обличчя.

She's got a small face.

She's got long brown hair.

She's got big green eyes.

She's got small ears.

She's got a small nose.

She's got a pink mouth.

She's got black glasses.

1



Look on the picture (p. 32, ex. 2) and write answers.

Поглянь на зображення (с. 32, впр. 2) і напиши відповіді.

- | | |
|--|--|
| 1 — Has she got a small face?
— Yes, she has. | 2 — Has she got red hair?
— No, she hasn't. |
| 3 — Has she got small eyes?
_____ | 4 — Has she got a small nose?
_____ |
| 5 — Has she got big ears?
_____ | 6 — Has she got a red mouth?
_____ |
| 7 — Has she got glasses?
_____ | 8 — Has she got long hair?
_____ |

2



Stick somebody's photo and write about him/her.

Наклей чиєсь фото та напиши про нього/неї.

Stick a photo



1 Read and colour. Write. Прочитай і розфарбуй. Напиши.

- 1 white 2 orange 3 blue 4 yellow 5 red 6 pink



1 My clown has got a white face.

2 _____

3 _____

4 _____

5 _____

6 _____

1



Count and write. Полічи та напиши.

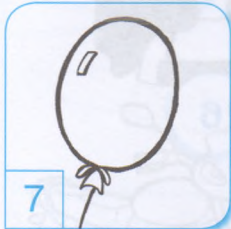

1 I've got seven balloons.

2 _____

3 _____

4 _____

5 _____

1



Look and number. Поглянь і пронумеруй.

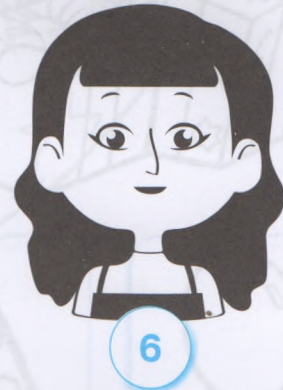
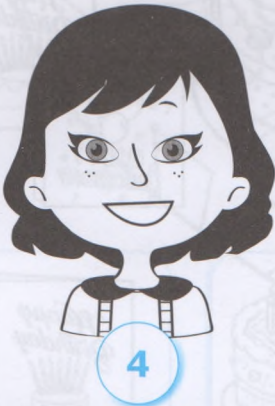

4 She's got grey eyes.

She's got blue glasses.

He's got a big nose.

He's got black glasses.

She's got big ears.

She's got a big mouth.

He's got small eyes.

He's got short blonde hair.

She's got blonde hair.

She's got long dark hair.

He's got blue eyes.

He's got a big face.



1

Fill in the blanks and match.
Заповни пропуски та з'єднай.



1

bus

ta _ i

bo _ t

lo _ _ y

sc _ _ ter

_ _ otor _ _ ike

h _ li _ opter

sk _ tebo _ rd



2



4



3

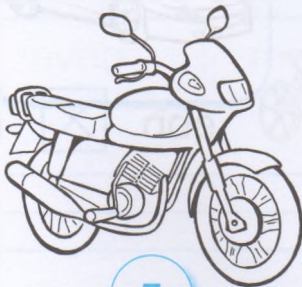

5

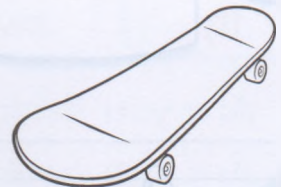

6





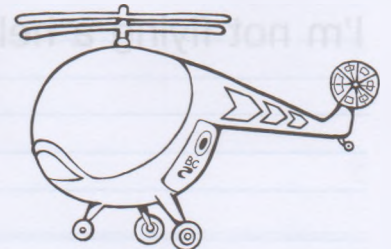

7

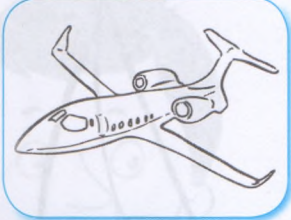
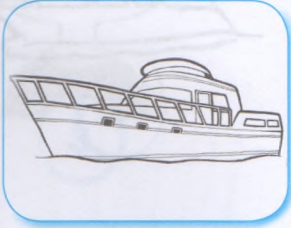

8

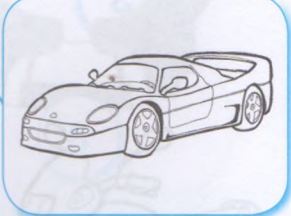
1  Read and match. Прочитай і з'єднай.

<p>1 I'm driving</p>	<p>a boat.</p>	
<p>2 I'm sailing</p>	<p>a car.</p>	
<p>3 I'm riding</p>	<p>a plane.</p>	
<p>4 I'm flying</p>	<p>a bike.</p>	

2  Copy. Перепиши.

I'm driving a lorry.

I'm not flying a helicopter.

1  **Make up sentences and write.** Утвори речення і напиши.

1 fly  I'm flying a helicopter.

2 drive  I'm not driving a bus.

3 fly 

4 sail 

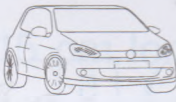
5 drive 

6 ride 

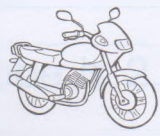



7 ride 

8 drive 

1  **Read and match.** Прочитай і з'єднай.

1	Are you riding a bike?	A	No, I'm not.
2	Are you flying?	B	It's a plane.
3	What are you doing?	C	Yes, I am.
4	What's your favourite transport?	D	I'm driving a car.

2  **Look and write.** Поглянь і напиши.

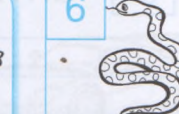
1	2	3	4	5	6
					
fly	swim	ride	fly	swim	drive

- 1 Are you flying? — Yes, I am.
- 2 Are you swimming? — No, I'm not.
- 3 _____
- 4 _____
- 5 _____
- 6 _____

1



Look and write. Поглянь і напиши.

1



15 cm

2

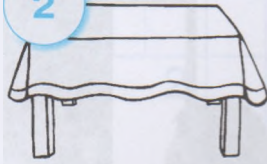

3 m

3



6 m 50 cm

4



8 m 30 cm

5



2 m 10 cm

6



40 cm

7



25 cm

8



10 m 15 cm

1 The pen is 15 cm long.

2

3

4

5 The wardrobe is 2 m and 10 cm tall.

6

7

8

1



Look and number. Поглянь і пронумеруй.



1



2



3



4

- The boy is going into the room.
- The boy is going out of the room.
- The boy is going up the stairs.
- 1 The boy is going down the stairs.

2



Сору. Перепиши.

What are you doing? — I'm going down the stairs.

1  Do the crossword 'Transport'.
Розгадай кросворд «Транспорт».

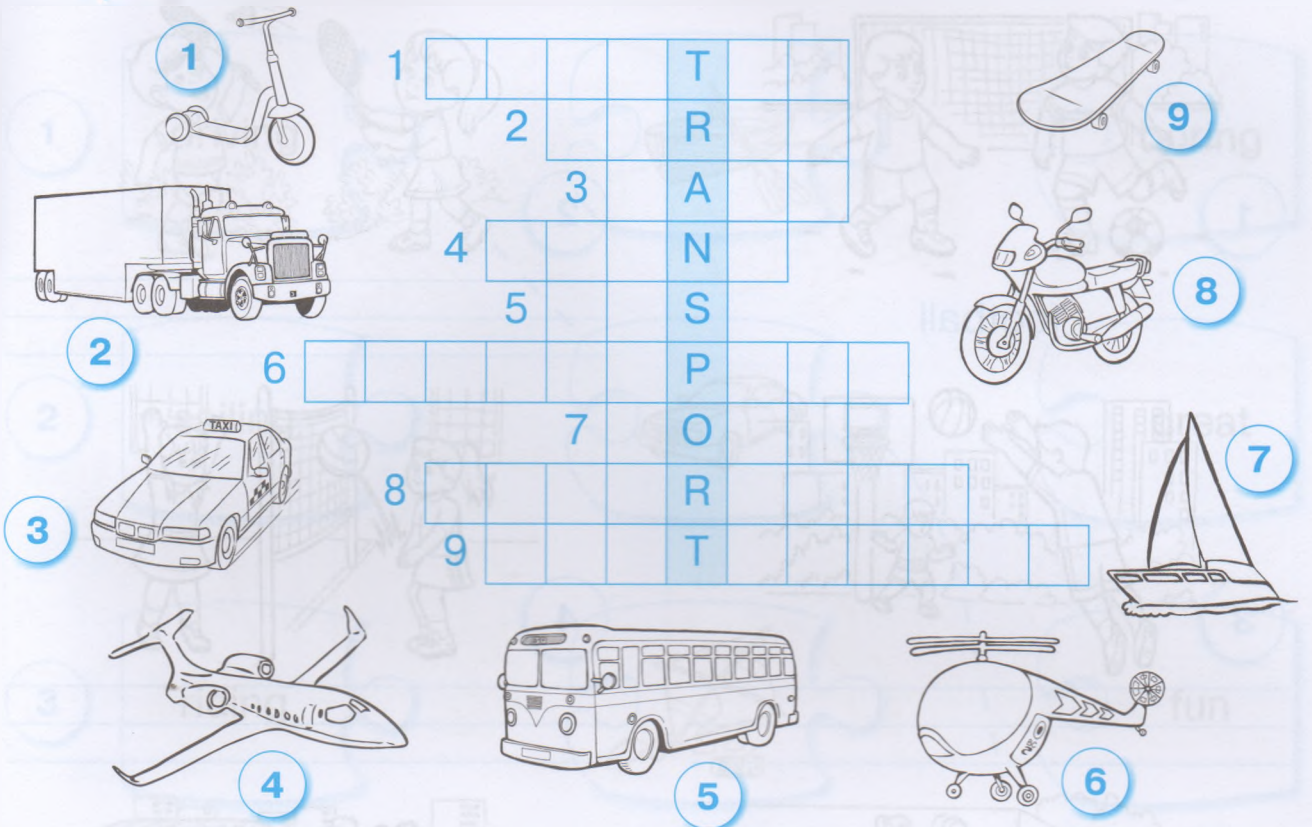

1				T		
	2			R		
		3		A		
	4			N		
		5		S		
2	6			P		
			7	O		
3	8			R		
		9		T		

2  Fill in the blanks. Заповни пропуски.

- transport
- long
- name
- riding
- orange

My (1) _____ is Jack. My favourite
 (2) _____ is a skateboard.
 My skateboard is 40 cm (3) _____.
 It's colour is (4) _____. I'm
 (5) _____ my skateboard every day.



1



Look and write. Поглянь і напиши.



1

football

2



3



4

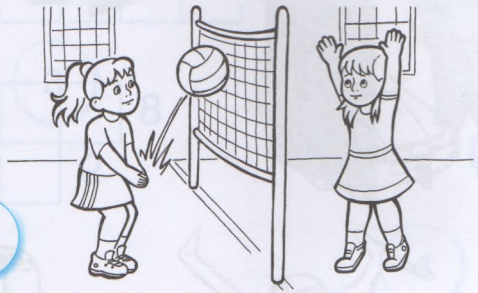

5

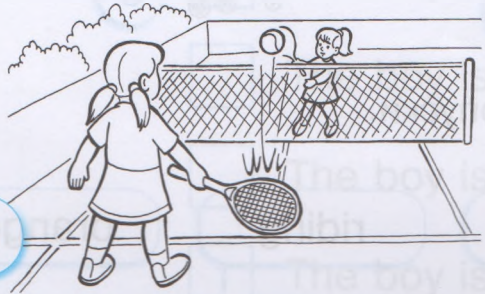

6



7

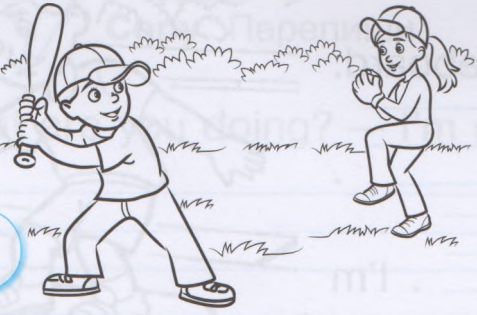

8

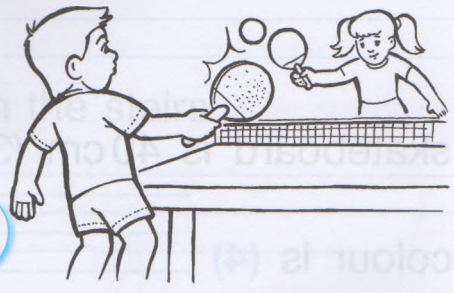

1



Match and write. З'єднай і напиши.

1

driving



boring

2

sailing



great

3

riding

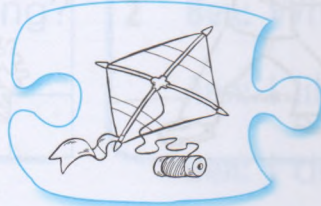

fun

4

flying



difficult

1 Driving a car is difficult.

2 _____

3 _____

4 _____

1



Number and write. Пронумеруй і напиши.

- 1 fun
- 2 great
- 3 boring
- 4 difficult



1 Playing football is great.

2

3

4

5

6

7

1



Look and write the dialogues.

Поглянь і напиши діалоги.

1



2



3



4



Ann



Ben



1 Ben: What do you like doing?

Ann: I like playing tennis.

Ben: Me too.

2 Ben: What do you like doing?

Ann: I like playing basketball.

Ben: I don't.

3 Ben:

Ann:

Ben:

4 Ben:

Ann:

Ben:

1  Fill in the blanks. Заповни пропуски.

1 
fun

2 
gr__t

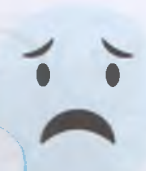
3 
b__r__ng

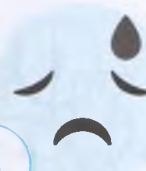
4 
d__ffi__ult

2  Find, circle 8 words and tick (✓).
Знайди, обведи 8 слів і познач (✓).

f	s	h	o	c	k	e	y	a	p	z	w	e	h	m	a	b
o	p	q	w	k	b	t	e	s	a	x	z	r	i	n	t	a
o	t	p	a	b	a	s	k	e	t	b	a	l	l	b	e	s
t	m	v	o	l	l	e	y	b	a	l	l	y	p	v	n	e
b	r	n	d	a	q	i	e	g	o	b	r	u	o	c	n	b
a	p	t	a	b	l	e	t	e	n	n	i	s	d	x	i	a
l	o	u	g	l	e	p	l	j	h	m	j	a	f	z	s	l
l	u	i	b	a	d	m	i	n	t	o	n	t	g	l	e	l

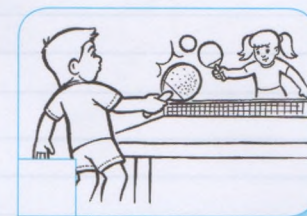
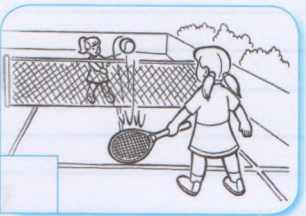

1

**Write questions and short answers.**

Напиши запитання і короткі відповіді.

1 Flying a kite is fun.

Is flying a kite fun? — Yes, it is.

2 Driving a lorry is easy.

Is driving a lorry easy? — No, it isn't.

3 Playing hockey is difficult. 4 Riding a motorbike is boring. 5 Playing baseball is great. 6 Playing table tennis is fun.

1  Circle the odd one out. Обведи зайве в кожному рядку.

1 hair fun eyes ears

2 easy difficult boring lorry

3 football skateboard bus motorbike

4 baseball tennis scooter volleyball

2  Make up sentences and write. Утвори речення та напиши.

1 tennis I'm playing tennis.

2 football I'm not playing football.

3 badminton

4 baseball

5 volleyball

6 hockey

1  **Play and say.** Пограйся і скажи.

She has got...

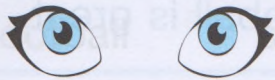

Spell.

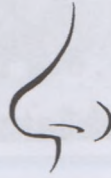

Has she got grey hair?



Has he got glasses?



Spell.



Playing tennis is...



What are you doing?

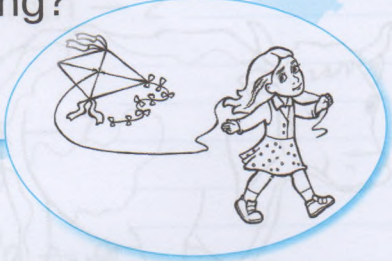

I'm not...



Spell.

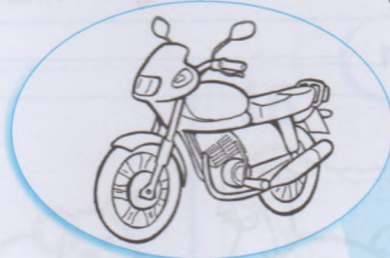

Are you sailing a boat?



What do you like doing?



Spell.



1



Look and write. Поглянь і напиши.

mouse horse cow sheep rabbit chicken goat



1

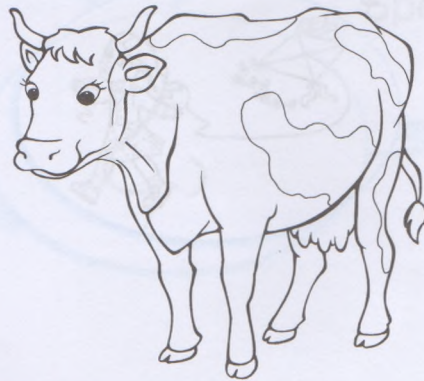

2



3



4



5



6



7

1  Write and read. Напиши та прочитай.

1 a child — 3 children

5 a mouse — 6

2 a woman — 2

6 a cat — 5

3 a boy — 7

7 a sheep — 9

4 a man — 4

8 a person — 8

2  Look and write. Поглянь і напиши.

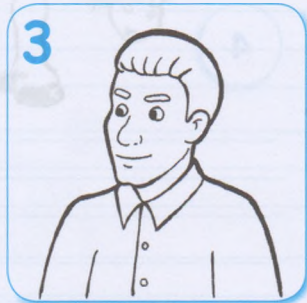

1 There are five women. — No, there are four women.

2 There are two men.

3 There are eleven mice.

4 There are fourteen sheep.

1



Colour and write. Розфарбуй і напиши.

1



I like rabbits.

Rabbits are grey.

2



3



4



5



6

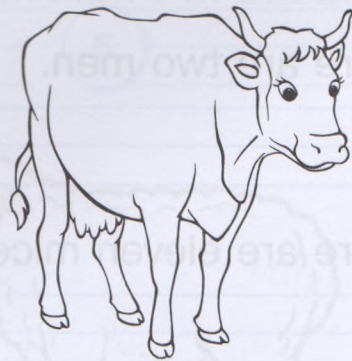

1



Look. Write questions and answers.

Поглянь. Напиши запитання і відповіді.

1



legs

2



ears

3



tails

4



legs

5



eyes

1 How many legs have horses got? — Horses have got four legs.

2

3

4

5

1



Look and write. Поглянь і напиши.

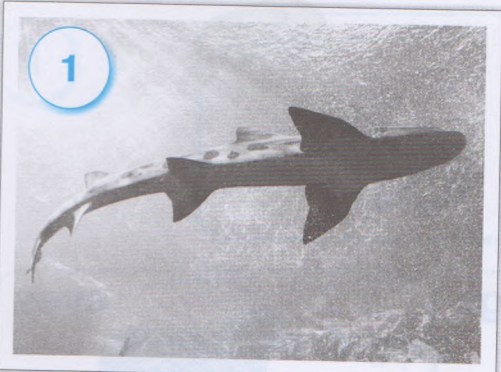

This is a shark. Sharks are fish.
They have scales.



Handwriting practice lines consisting of multiple horizontal blue lines.

1



Look and write. Поглянь і напиши.

Don't run! Smile! Listen to your teacher!
Look at the camera! Watch out! Help!



1



2



3



4



5



6

1  **Number and complete.**
Пронумеруй і допиши.

- 1 zoo
- 2 countryside

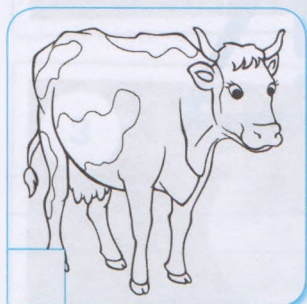

At the zoo I can see parrots, _____

In the countryside I can see goats, _____

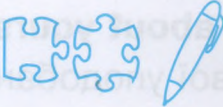
1  Match and write. З'єднай і напиши.



ride a roller coaster



ride a horse



win a prize



eat a sandwich

1 I'm drinking lemonade.

2 _____

3 _____

4 _____

5 _____

6 _____



1 Fill in the blanks. Complete the sentence about yourself.
Заповни пропуски. Допиши речення про свої уподобання.

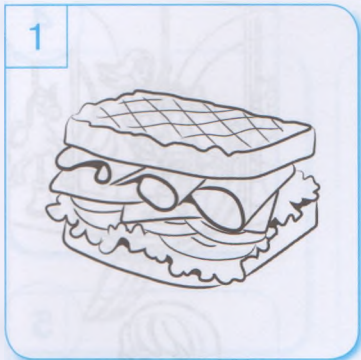

eat a sandwich



ride a



win a



drink

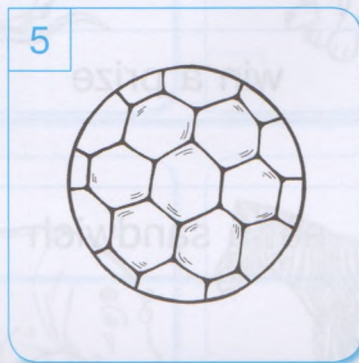

throw a

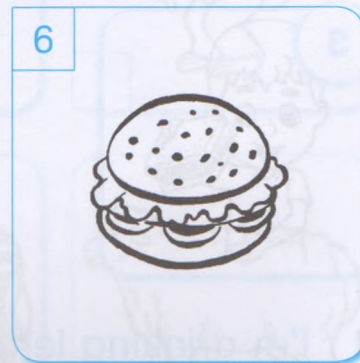

buy a

I'd like to

1
2
3
4
5



1

Match and write. З'єднай і напиши.



1



2



3



4



5



win

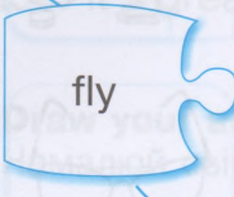

fly

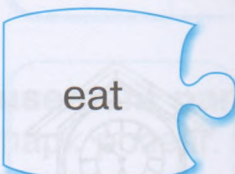

eat

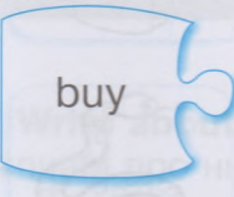

buy

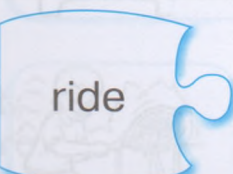

ride



a bike



an
apple



a cake

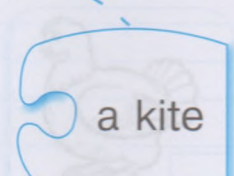

a kite

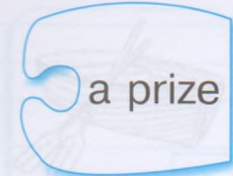

a prize

1 I'd like to fly a kite.

2 _____

3 _____

4 _____

5 _____

1  **Read and number.** Прочитай і пронумеруй.

- | | | | | |
|----------|---------|-----------|------------|------------|
| 1 clock | 2 horse | 3 hippo | 4 mouth | 5 bookcase |
| 6 taxi | 7 sofa | 8 glasses | 9 burger | 10 hockey |
| 11 chips | 12 boat | 13 snake | 14 chicken | 15 tennis |

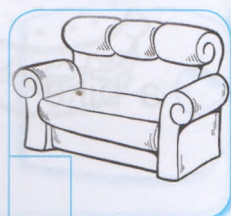
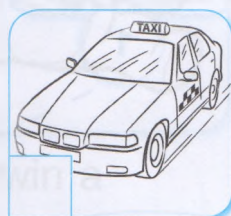

2  **Circle the odd one out.** Обведи зайве в кожному рядку.

1 cow child sheep rabbit

2 burger lemonade chips prize

3 horse eat drink win

4 leg tail car nose

1



Stick a photo of your family and write about it.

Наклей фото своєї сім'ї та напиши про неї.



Stick a photo

Handwriting practice lines consisting of multiple horizontal blue lines for writing.



1

Find and circle 6 words. Complete.

Знайди й обведи 6 слів. Допиши.

t	b	a	s	k	e	t	b	a	l	l	t	u	r	w	a	g
g	h	j	k	z	x	c	v	z	n	m	k	z	x	c	k	b
w	d	f	a	h	s	u	n	p	r	i	z	e	s	u	p	u
b	q	w	e	r	t	y	u	i	o	p	e	r	t	y	r	r
a	a	r	o	l	l	e	r	c	o	a	s	t	e	r	q	g
l	f	g	h	j	k	l	z	x	c	u	h	j	k	l	p	e
l	v	b	n	m	o	l	e	m	o	n	a	d	e	i	u	r

1 to play a **basketball**

4 to eat a _____

2 to win a _____

5 to drink _____

3 to ride a _____

6 to throw a _____

2



Read and match. Прочитай і з'єднай.

1

Are you buying chips?

A

Yes, I can.

2

Can you touch your toes?

B

Table tennis.

3

Does he like riding a horse?

C

No, I'm not.

4

What sport do you like?

D

Yes, he does.



1

Match and number. З'єднай і пронумеруй.

1 swim

an ice cream

2 take

a sandcastle

3 make

a fish

4 eat

a photo

5 listen

in the sea

6 catch

a picture

7 paint

to music

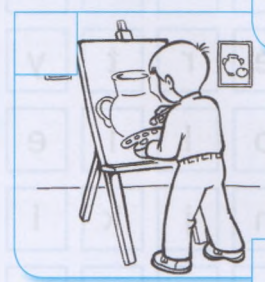

1  **Complete and write answers.**
Допиши речення і напиши відповіді.



Good idea.



I'm not sure.



Sorry, I don't want to.

1  — Let's listen to music.



— I'm not sure.

2  — Let's take



3  — Let's paint



4  — Let's look



5  — Let's make



1  Tick (✓) 6 pictures and write. Use the example.
Познач (✓) 6 малюнків і напиши за зразком.

Let's catch a fish and swim in the sea.



1 _____

2 _____

3 _____

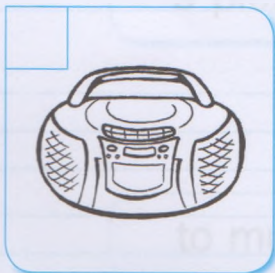

1



Write and say. Напиши та скажи.

happy

old

new

interesting

ugly

beautiful

They are happy.



1

happy



2



3



4

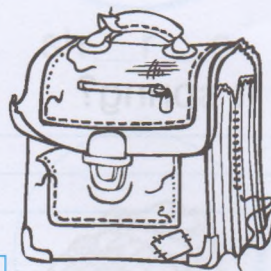

5



6

2



Make up a sentence and write. Утвори речення і напиши.

is / it. / beautiful / I / photo / The / and / like

1



Make up words and write. Утвори слова та напиши.

u m m e r s

summer

i n t e r w

u t u m n a

p r i n g s

2



Look and write answers. Поглянь і напиши відповіді.



1 Is it winter?

No, it isn't. It is spring.



2 Is it spring?



3 Is it summer?



4 Is it autumn?



1

Fill in the blanks and match. Say.

Заповни пропуски та з'єднай. Скажи.

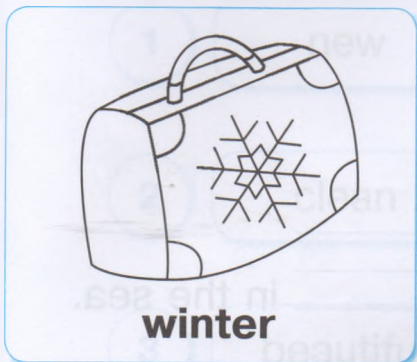

Boots are for winter.



1



Number and fill in the blanks.

Пронумеруй і заповни пропуски.



1 Let's look for shells.

2 Let's _____ in the sea.

3 Let's _____ a picture.

4 Let's _____ a fish.

5 Let's _____ a photo.

6 Let's _____ to music.

7 Let's _____ a sandcastle.

8 Let's _____ an ice cream.

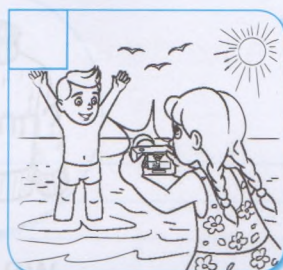
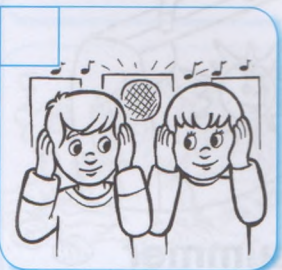

2



Match the opposites. З'єднай протилежності.

1	new	ugly
2	clean	boring
3	beautiful	old
4	interesting	dirty

3



Look and write. Поглянь і напиши.

1		2		3		4		5	
	ugly		new		interesting		beautiful		old

1 The monster is ugly, but I like it.

2 _____

3 _____

4 _____

5 _____

1  Play and say. Пограйся і скажи.

How many legs have sheep got?



Spell.



Spell.



Let's...



Do you like...?



My country is...



Mammals
have...



I'd like
to drink...



The bag is...

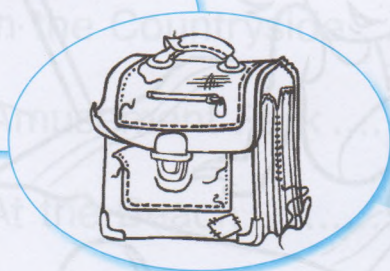

Spell.



Spell.



Sandals are
for...

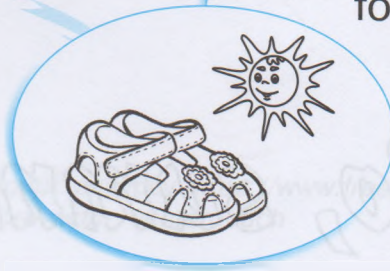

1



Colour and read. Розфарбуй і прочитай.

Goodbye, school!

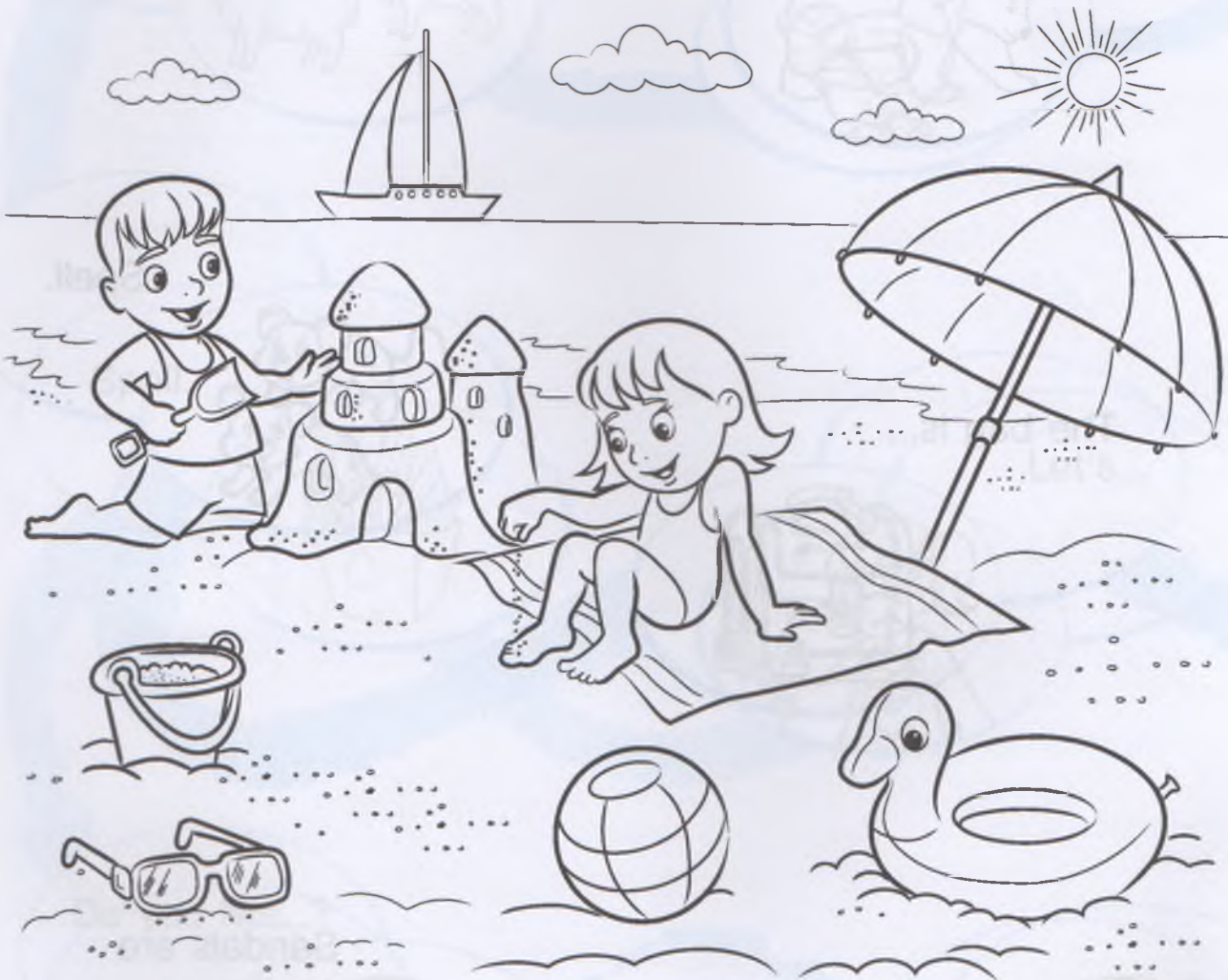

Hello, summer holidays!

CONTENTS

Back to School	3
Unit 1. The School Bag	7
Unit 2. The Zoo	14
Unit 3. My Bedroom	21
Units 1, 2, 3. Review	28
Unit 4. Come to My Party!	30
Unit 5. Off We Go!	37
Unit 6. Sports Club	44
Units 4, 5, 6. Review	52
Unit 7. In the Countryside	54
Unit 8. Amusement Park	61
Unit 9. At the Beach	68
Units 7, 8, 9. Review	76

У посібнику використано матеріали з інтернет-ресурсу <https://www.freepik.com>
авторів: *brgfx, freepik, macrovector, vectorpouch*